

Data Sheet

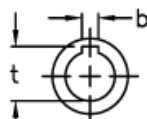

Article number: 2301077121
Description: E+G Handwheel
VR.100 FP+I

Measures

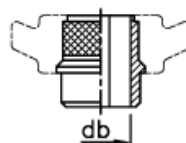
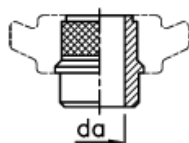
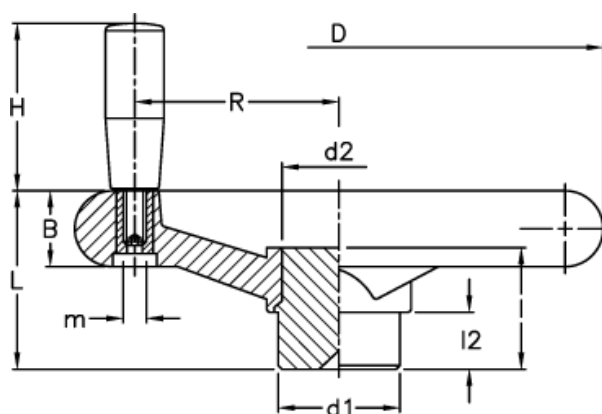

da max tilladelig boring uden not

db max tilladelig boring med not

b	= 5	H	= 40
B	= 14	l	= 36
C (N m)	= 67	L	= 40
D	= 98	L (J)	= 5
d1	= 24	l2	= 12
d2	= 20	m	= M6
da	= 16	R	= 37
db	= 13	t	= 15.3